

FM/LW/MW/SW
4-Band Portable Radio

MODEL NO. **RF-B600**

Operating Instructions

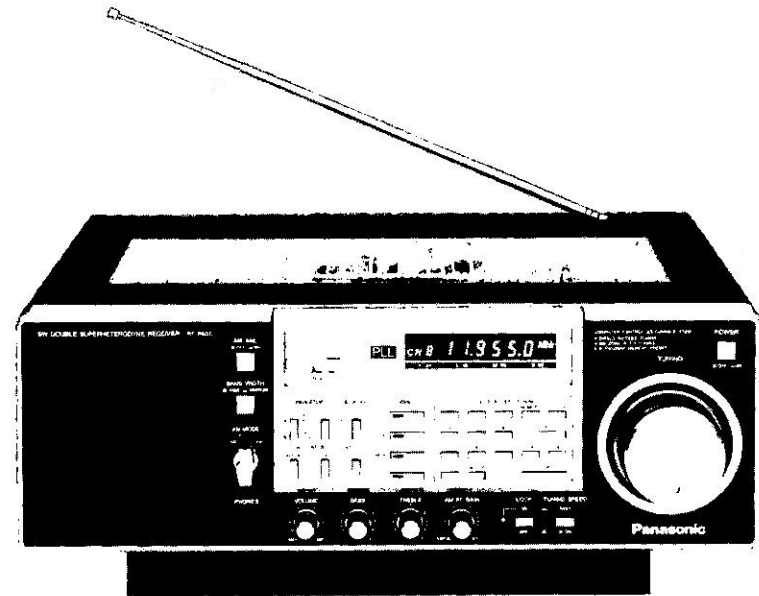

Panasonic®

Read these instructions completely before operating this set.

Thank you for purchasing this Panasonic Radio. For optimum performance, follow these operating instructions carefully.

WARNING:

TO PREVENT FIRE OR SHOCK HAZARD, DO NOT EXPOSE THIS PRODUCT TO RAIN OR MOISTURE.

CAUTIONS:

- Voltage ranges 110–115 V, 200–220 V and 230–250 V are not for use in the U.S.A. (in the U.S.A. use 115–127 V)
- Operation at voltage settings higher than 127 V AC may require the use of a different AC plug. Please contact either a local or foreign Panasonic Authorized Servicenter for assistance in selecting an alternate plug adaptor.

The serial number of this product may be found on the label affixed to the inside of the radio battery compartment.

You should note the serial number of this unit in the space provided below, and retain this book as a permanent record of your purchase to aid in identification in the event of a fire or theft.

MODEL NUMBER: RF-B600 _____

SERIAL NUMBER: _____



CAUTION

RISK OF ELECTRIC SHOCK
DO NOT OPEN



CAUTION: TO REDUCE THE RISK OF ELECTRIC SHOCK, DO NOT REMOVE SCREWS. NO USER—SERVICEABLE PARTS INSIDE. REFER SERVICING TO QUALIFIED SERVICE PERSONNEL.



The lightning flash with arrowhead symbol, within an equilateral triangle, is intended to alert the user of the presence of uninsulated "dangerous voltage" within the product's enclosure; that may be of sufficient magnitude to constitute a risk of electric shock to persons.



The exclamation point within an equilateral triangle is intended to alert the user of the presence of important operating and maintenance (servicing) instructions in the literature accompanying the appliance.

PRECAUTIONS

- For your safety and to prevent damage to the set:
- Do not connect the set to any AC outlet other than the type supplying the specified voltage.
 - Avoid cuts, scratches, or poor connections in the AC power cord, as they may result in possible fire or electric shock hazard. Also, excessive bending, pulling or slicing of the cord should be avoided.
 - Do not unplug the AC power cord by pulling on the cord. To do so may cause premature failure or shock hazard.
 - Do not operate the set on AC power in a bathroom, as a potential shock hazard may result.
 - When not in use, disconnect the AC power cord from the AC power outlet.

HELPFUL HINTS

- If the set is not used for a long period of time or is used only from an AC power source, remove all the batteries to prevent potential damage due to possible battery leakage.
- When the sound begins to lower, it is advisable to replace all the main batteries with new ones before they are completely discharged.
- Do not subject the set to a temperature of over 140°F (60°C), because characteristics of the internal parts may be adversely affected by heat. Especially, never leave the set in a car exposed to direct sunlight for a long period of time with all the doors and windows closed. The cabinet may become deformed, and deterioration of the performance may result.
- Do not use benzine, thinner or the like, or any abrasive powder to clean the cabinet. Wipe it with a soft cloth moistened with a mild soap and water solution.
- If this unit is moved from a cold area (say 0°C) to a warm place it may not operate normally. This is the result of moisture in certain areas. In approximately 60 minutes, the unit will be operating correctly.

TABLE OF CONTENTS

PRECAUTIONS	1
HELPFUL HINTS	1
POWER SOURCE	2
LOCATION OF CONTROLS AND THEIR FUNCTIONS	3
ANTENNAS	6
RECEIVER OPERATION	7
Before Tuning Operation	7
• Direct-Access Tuning	8
• Manual Tuning	9
• Memory Tuning	10
• Memory Scan Tuning	10
• SW Zone Auto Tuning	11
CONNECTIONS	13
SUGGESTIONS FOR SAFETY	14
SPECIFICATIONS	Back Cover
PRODUCT SERVICE	Back Cover

POWER SOURCE

Before use, make sure that the memory back-up batteries are installed.

■ Memory back-up batteries

- 1) Open the battery compartment cover as shown in the figure below.

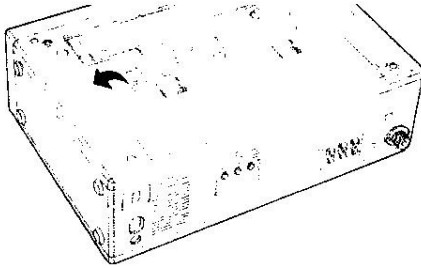

- 2) Insert 3 "AA" size batteries (Panasonic UM-3 or equivalent) into the battery compartment, making sure that the proper polarities (+ and -) are maintained.

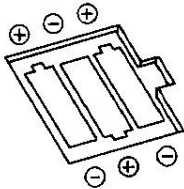

(These batteries should be replaced once per year if the main batteries are installed.)

- 3) Replace the compartment cover.

Note:

When replacing the memory back-up batteries, make sure that the AC power cord is in an AC outlet. Otherwise, the memory will be lost.

■ Battery Operation

- 1) Open the battery compartment cover as shown in the figure below.

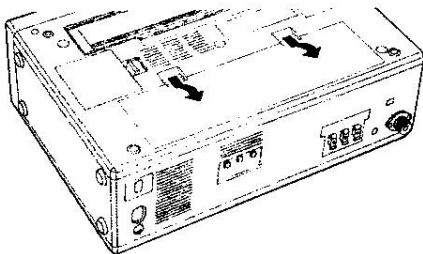

- 2) Insert 8 "D" size (Panasonic UM-1 or equivalent) batteries into the battery compartment, making sure that the batteries are installed in the designated numerical order and that the proper polarities (+ and -) are maintained.

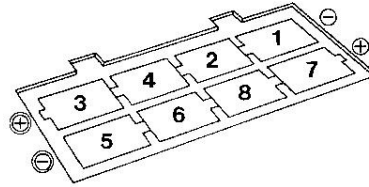

- 3) Replace the compartment cover.

● Battery removal

Remove the batteries as shown in the figure below.

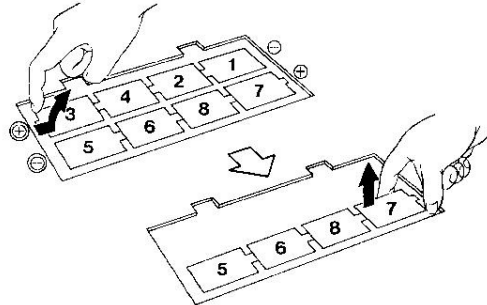

● Battery life

- 1) Set the Power Switch to "ON".
- 2) Set the Indicator Switch to "BATT".
The Battery Check/Tuning/Signal Indicator will then show the battery condition.



YES

When the meter points within the range as shown, the batteries can be used.

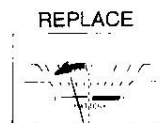

NO

When the meter points within the range as shown, replace all the batteries with new ones.

Note:

To operate on battery power, unplug the AC power cord from the household AC power outlet and the AC Socket on the unit, the unit will automatically switch to the batteries.

■ AC Power Operation

- 1) First, check the AC Voltage Selector to insure that it is set to the voltage which corresponds to your household AC voltage. If not, select the proper voltage by inserting a small screwdriver into the slot provided and turning the screwdriver until the desired voltage appears through the opening.

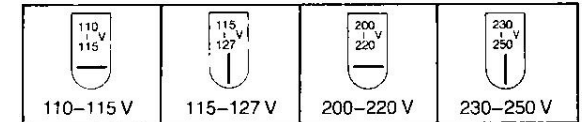

- 2) Connect the accessory AC power cord to the AC Socket in the unit and your household AC power outlet. Upon plugging the power cord into the AC Socket, the unit will automatically switch from battery to AC operation.

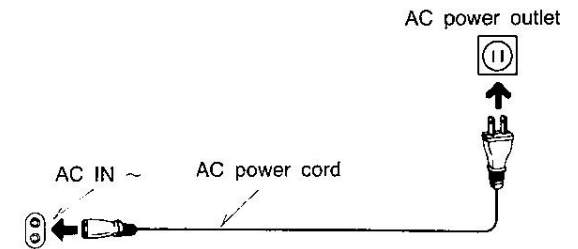

■ Car Battery Operation

- 1) Insert the plug of the car adaptor cord into the DC Input Jack.
- 2) Plug the opposite end of the cord into the cigarette lighter socket in your car. Upon plugging the car adaptor cord into the DC Input Jack, the unit will automatically switch from internal battery to car battery operation.

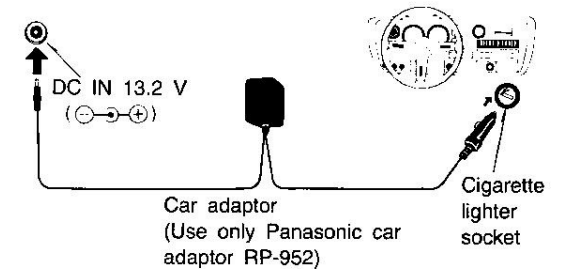

Note:

For the connection of an adaptor cord, follow the instructions provided with the cord.

LOCATION OF CONTROLS AND THEIR FUNCTIONS

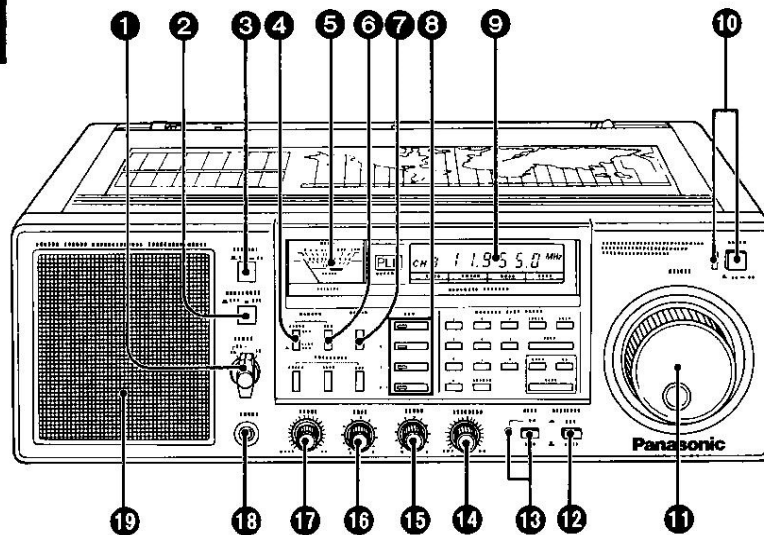

1 AM Mode Selector (AM MODE)

This is used for selecting between the LSB/CW, USB/CW, and AM modes.

2 AM Band Width Selector (BAND WIDTH)

This function is used when receiving AM (LW, MW, SW) broadcasts, and normally is set in the "■ WIDE" position. When frequencies are very close together and signal mixing occurs, set to the "■ NARROW" position. When receiving LSB/CW or USB/CW broadcast, it is automatically set to the "■ NARROW" position.

3 AM ANL (Automatic Noise Limiter) Switch (AM ANL)

When receiving AM (LW, MW, SW) broadcasts, this switch is used to eliminate unwanted noise caused by automobile ignitions, etc.

4 Indicator Selector (SELECTOR)

This is used to select between the battery check, tuning, and signal strength indicator functions.

■ BATT: In this position, the meter indicates the battery consumption level for radio operation.

■ TUNING/SIGNAL: In this position, the meter indicates the frequency tuning accuracy and the signal strength.

5 Battery Check/Tuning/Signal Indicator (INDICATOR)

This indicates battery consumption level, tuning accuracy, and signal strength.

6 Indicator Light Switch (LIGHT)

When depressed to the "■ ON" position, meter illumination is turned on. Use this function at night when the meters are hard to read. When not in use, depress it to the "■ OFF" position.

7 Display Switch (DISPLAY)

When depressed to the "■ ON" position, the digital frequency display will appear. Depress it to "■ OFF" position to save the battery life.

8 Band Select Keys/Indicators (BAND)

These keys are used for selecting the desired band. When each key is pressed, its corresponding indicator will light.

9 Digital Frequency Display (DIGITAL FREQUENCY DISPLAY)

This display shows the frequency and the number of the memory channel.

10 Power Switch/Indicator (POWER)

When depressed to the "■ ON" position, the indicator lights, and power is supplied to the unit. Always set the switch to the "■ OFF" position after use.

11 Tuning Control (TUNING)

This control dial is used for Manual Tuning.

12 Fast/Slow Tuning Speed Selector (TUNING SPEED)

This is used in the following way to select the tuning steps or increments:

Band Position	FM	LW/MW	SW
■ FAST	100 kHz	10 kHz	1 kHz
■ SLOW	50 kHz	1 kHz	100 Hz

(This function does not operate during SW Zone Auto Tuning)

13 Tuning Lock Switch/Indicator (LOCK)

Usually set this switch to the "■ OFF" position. When set to the "■ ON" position, the indicator lights, the frequency presently being received will be locked and can not be drifted accidentally.

14 AM RF Gain Control (AM RF GAIN)

Normally, it is set in the "DX" position. When signals are weak and accompanied by distortion, or when signal mixing occurs, turn the control toward the "LOCAL" direction, and adjust to the position for optimum listening.

15 Treble Control (TREBLE)

16 Bass Control (BASS)

17 Volume Control (VOLUME)

18 Headphone Jack (PHONES)

This jack is used for connecting headphones with an RCA (1/4") plug.

Avoid listening to sound at high levels for prolonged periods. This may injure your ears.

19 Built-in Speaker

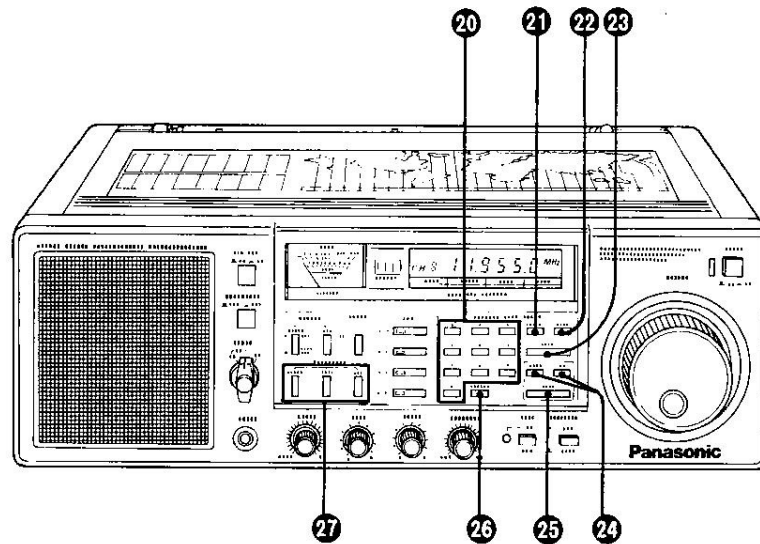

20 Key (Number 1–9 are used for memory and 0 for frequencies)

These keys are pressed to enter the frequency of a desired station, or to enter the memory channels.

21 Memory Key (MEMORY)

This key is pressed first when entering the frequency number of a desired station into the memory channel.

22 Direct Key (DIRECT)

This key is pressed before pressing in the frequency number of your desired station. Also, if you make a mistake when pressing the Number Keys, this key can be pressed to cancel the mistaken selections.

23 Enter Key (ENTER)

After entering the frequency number of your desired station, this key is pressed to begin receiving the broadcast of the station.

24 Tuning Keys (DOWN, UP)

These keys are pressed when performing SW Zone Auto Tuning.

25 Stop Key (STOP)

This key is pressed to stop the Memory Scan Tuning, Seek Tuning or Memory Scan Tuning.

26 Decimal Point/Memory Scan Key (•/M-SCAN)

This key is pressed for entering the decimal fraction portion of a frequency number and for playing back the memory channels.

When this key is pressed, the stations previously memorized in the memory channels will be played back for about 3 seconds each, moving in order from one channel frequency to the next (1CH→2CH.....9CH→1CH→2CH...). To cancel this operation, press either the Stop Key or one of the Memory Channel Keys.

27 SW Zone Auto Tuning Selector (SW ZONE AUTO TUNING)

When receiving short-wave broadcasts, these keys are used to tune up or down in 5 kHz increments within a ± 150 kHz zone around a selected central frequency.

“MANUAL”: This allows you to perform tuning at every 5 kHz within the zone by one touch of the Tuning Keys.

“SCAN”: When one of the Tuning Keys is pressed once, the unit will scan for signals within the selected zone if any, playing each station for about 3 seconds before moving automatically to the next station in the zone. To stop this operation, press the Stop Key.

“SEEK”: When one of the Tuning Keys is pressed once, the unit will receive signals within the selected zone if any, and stop the Auto Tuning Function.

To Stop the operation before receiving the signals, press the Stop Key.

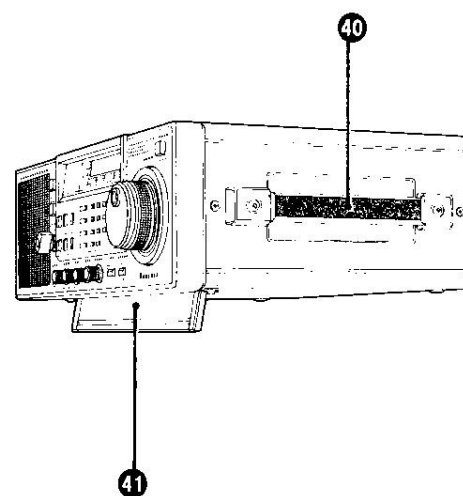
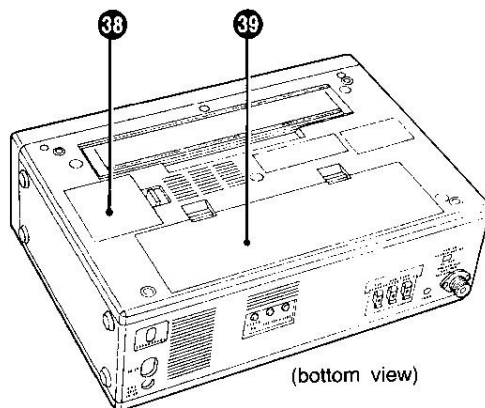
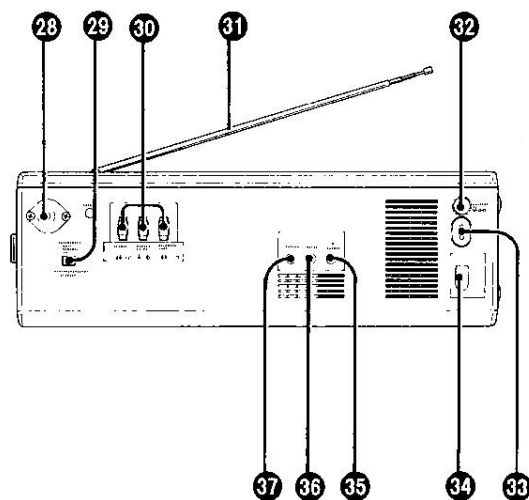

28 AM Low Impedance External Antenna Terminal (LW/MW/SW ANT 50-75Ω)

29 SW Antenna Selector (SW INT ANT/SW ANT)
This is used for switching between the short-wave built-in and outdoor antennas, and for selecting HIGH or LOW impedance. When set to "LOW IMP", the telescopic antenna connection will be disconnected.

30 External Antenna Terminals (LW/MW/SW ANT · SW ANT · FM ANT)
(Low Imp) (High Imp)

When reception is difficult with the built-in antenna alone, an optional outdoor antenna can be connected to these terminals.

31 Telescopic Antenna

32 DC Input Jack (DC IN 13.2 V →)

This jack is used when connecting a car adaptor (use only RP-952) for use with an automobile battery (DC 12 V).

33 AC Socket (AC IN ~)

The accessory AC power cord is connected here when using the unit with household (AC 120 V) current.

34 Voltage Selector (VOLTAGE SELECTOR)

35 External Speaker/Earphone Jack (IMP 8Ω ONLY)

When an optional external speaker or earphone is connected here, the built-in speaker is disconnected, allowing you to listen from the external speaker or earphone.

When connecting the Headphones, the earphone connected to this jack is automatically disconnected.

●Adjust the volume to lower level when using an earphone.

36 Recording Output Jack (REC OUT)

If a tape recorder is connected to this jack, you can record radio broadcasts while listening to them at the same time. Depending on the kind of input jack on your tape recorder, the connection cord required may differ.

Note:

The output level during recording is fixed regardless of the position of this unit's Volume Control.

37 Stand-by Jack (STAND BY)

When using the unit as a receiver of an amateur station by connecting the stand by jack of a transmitter to this jack, radio operation is automatically muted during reception.

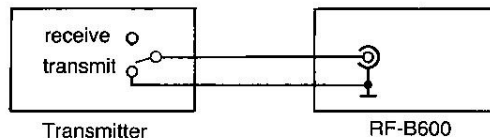

38 Battery Case (For Memory Back-up)

3 "AA" size batteries are inserted here.

39 Battery Compartment (For Radio Power)

8 "D" size (Panasonic UM-1 or equivalent) batteries are inserted here.

40 Carrying Handle

41 Stand

For easy operation, set the unit on the table by the stand.

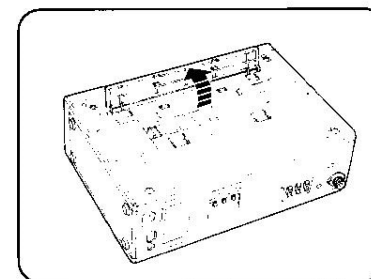

ANTENNAS

■ Built-in Antennas

FM:

- Extend the Telescopic Antenna completely and adjust its length and angle for optimum reception.

LW/MW:

- The sensitive ferrite core antenna inside the set will provide excellent LW/MW reception in most areas. For optimum reception, turn the set in the direction which gives the best results, since the ferrite core antenna is directional.

SW:

- Extend the Telescopic Antenna completely, keeping it vertical.

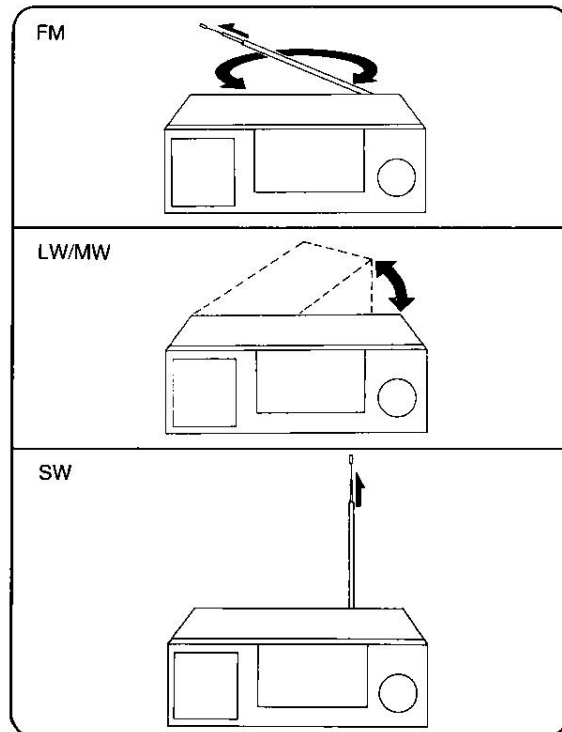

■ External Antennas

- To improve reception further:
Refer to the figure below for proper connection of the different kinds of antenna.
- If an AM (LW, MW, SW) External Antenna is connected, be sure to set the SW Antenna Selector to the position corresponding to the antenna used.

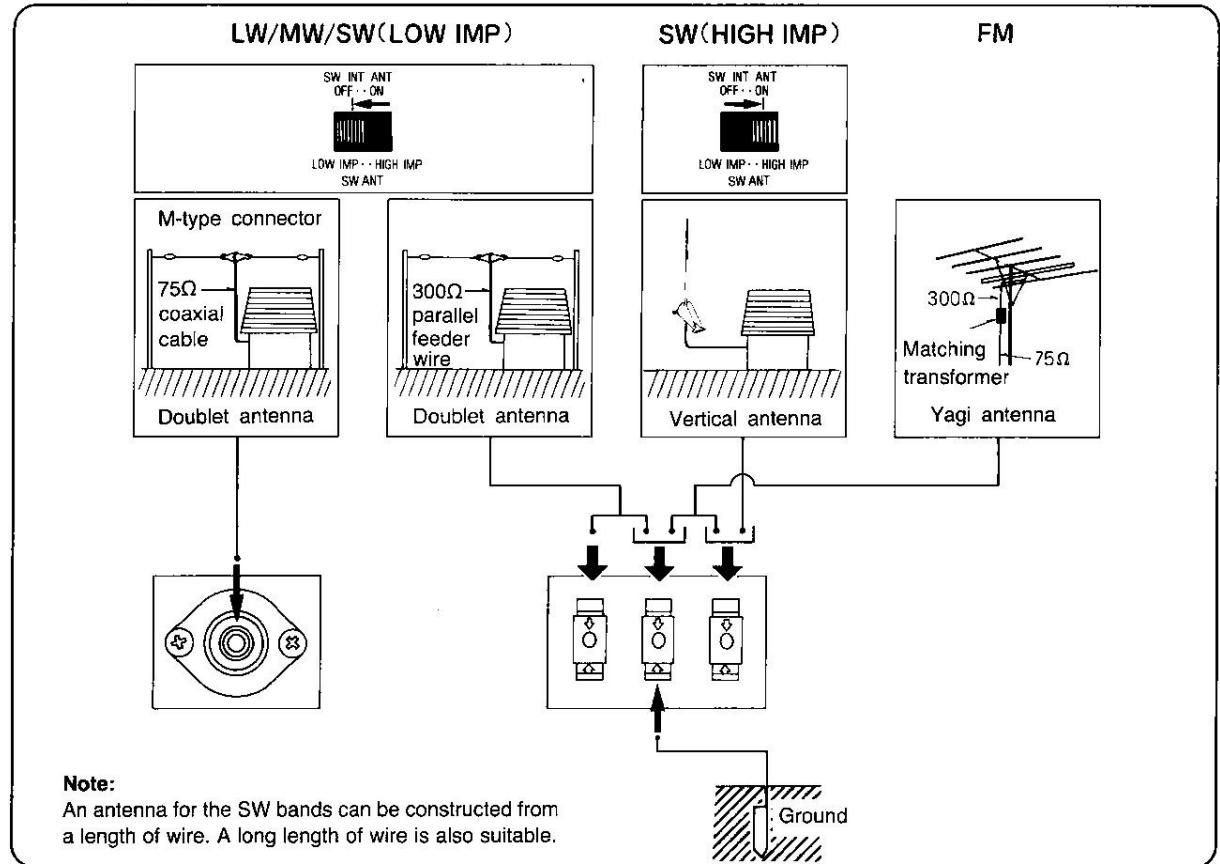
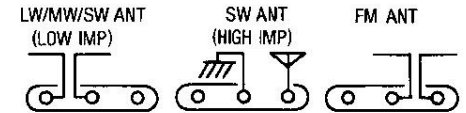

•Connecting an M-type connector

(Use 75Ω coaxial cable for connection.)

- ① Remove the cover of the Coaxial cable by about $\frac{25}{32}$ "
- ② Untie the Braided wire (shield wire) and separate it from the Core.
- ③ Remove the cover of the Core by about $\frac{3}{8}$ "
- ④ Solder the Core and Braided wire to the supplied M-type connector

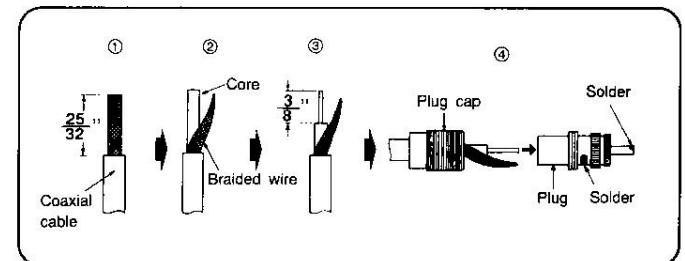

RECEIVER OPERATION

Perform the appropriate receiver operations in accordance with the type of broadcast you wish to listen to.

A Direct-Access Tuning

When you know the frequency number of your desired station.

B Manual Tuning

When you do not know the frequency number of your desired station.

C Memory Tuning

For performing one-touch tuning of memorized stations.

D Memory Scan Tuning

For performing automatic scanning of memorized stations.

E SW Zone Auto Tuning

Use during short-wave reception, when you wish to look for stations within a ± 150 kHz range of a central frequency.

Before Tuning Operation

Be sure to check the following points before operating this unit.

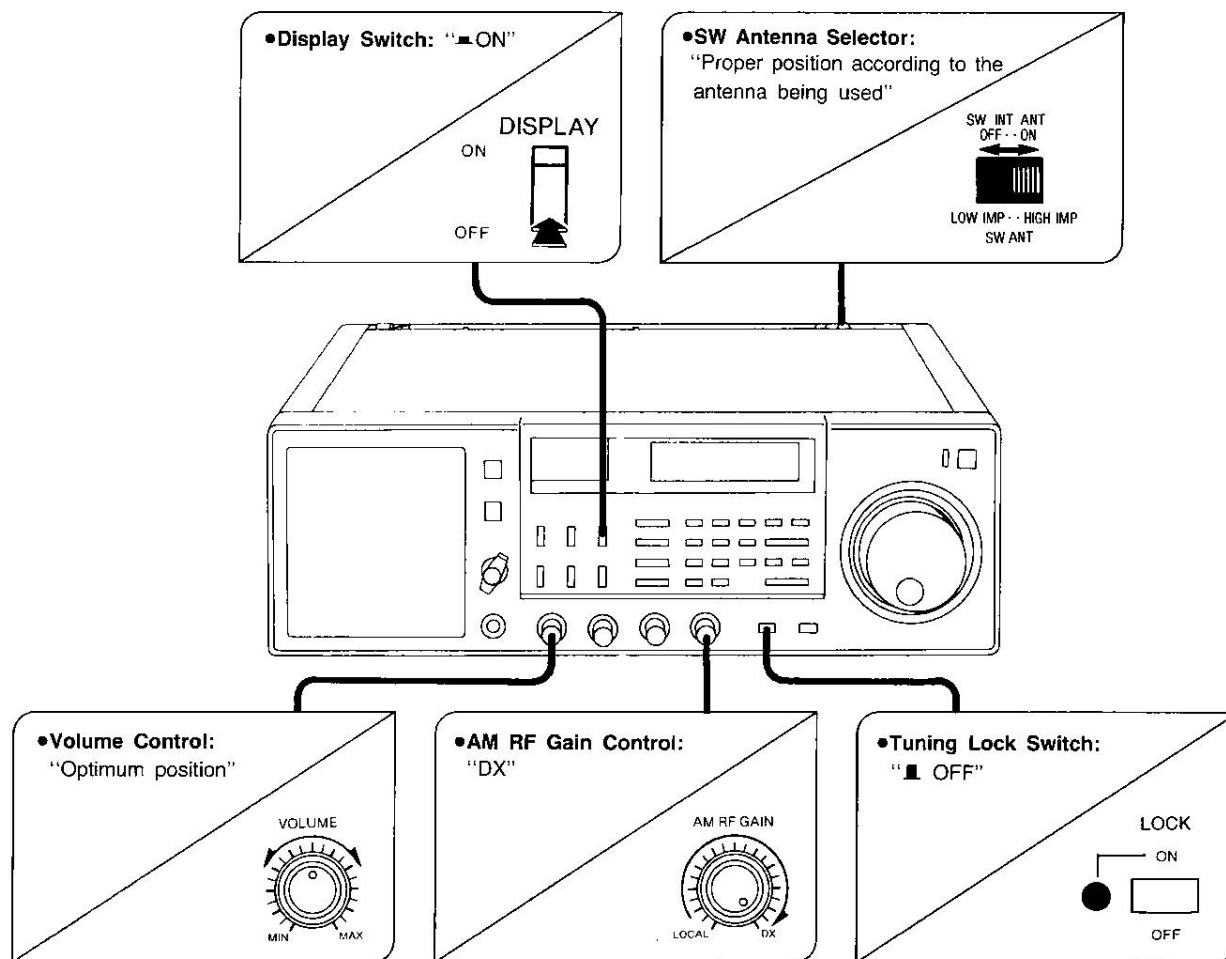

SW broadcast is greatly affected by any slight change in solar spots and by different seasons. In these cases, reception is often impossible, but this does not mean there is any defect of the unit. In this case, please wait until proper receiving conditions are present.

Note:

After tuning: If the Tuning Lock Switch is set to "ON", its indicator will light, and the frequency presently being received will be locked. In this way, even if you accidentally touch the Tuning Control, the frequency will not be affected.

A Direct-Access Tuning

Use this tuning mode when you know the frequency number of your desired station.

Note:

After pressing the Direct Key, or between pressing one Number Key and the next, if more than 5~6 seconds is allowed to elapse, the Digital Frequency Display will return to the display of the last station frequency received.

■ About the Error Display

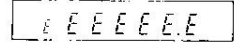

During Direct-Access Tuning mode, the Error Display will occur when the reception frequency band is set outside of the broadcasting band or the Enter Key is pressed while the frequency band has not been set. In this case, enter the correct frequency band.

The frequency ranges of this unit are as follows:

FM: 87.5~108 MHz

LW: 150~420 kHz

MW: 520~1610 kHz

SW: 1.611~29.9999 MHz

(Direct-Access Tuning enables reception up to 29.999 MHz.)

1 Set the Power Switch to the "ON" position.

After use, set to the "OFF" position.

2 Press the Direct Key.

(The digital frequency display contents will disappear.)

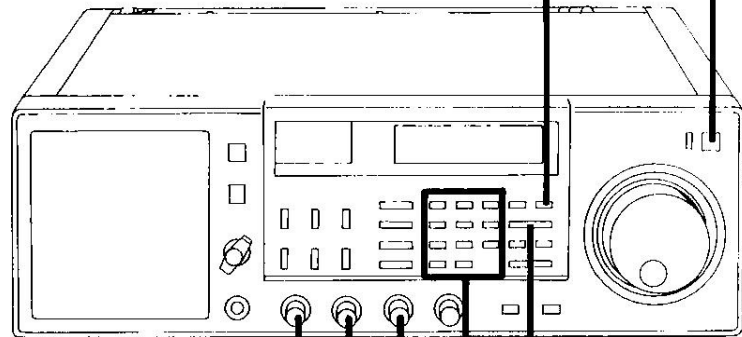

3 Use the Number Keys to enter in the desired station frequency, and then press the Enter Key.

<p>Example: SW 11.955 MHz</p> <p>(Tuning is completed)</p>	<p>Example: MW1010 kHz</p> <p>(Tuning is completed)</p>	<p>Example: LW 236 kHz</p> <p>(Tuning is completed)</p>	<p>Example: FM 88.10 MHz</p> <p>(Tuning is completed)</p>
--	---	---	---

4 Adjust the Volume, Bass and Treble Controls.

B Manual Tuning

Use this tuning mode when you do not know the frequency of your desired station.

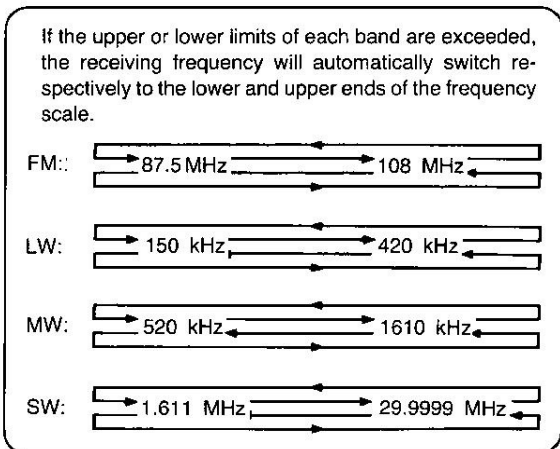
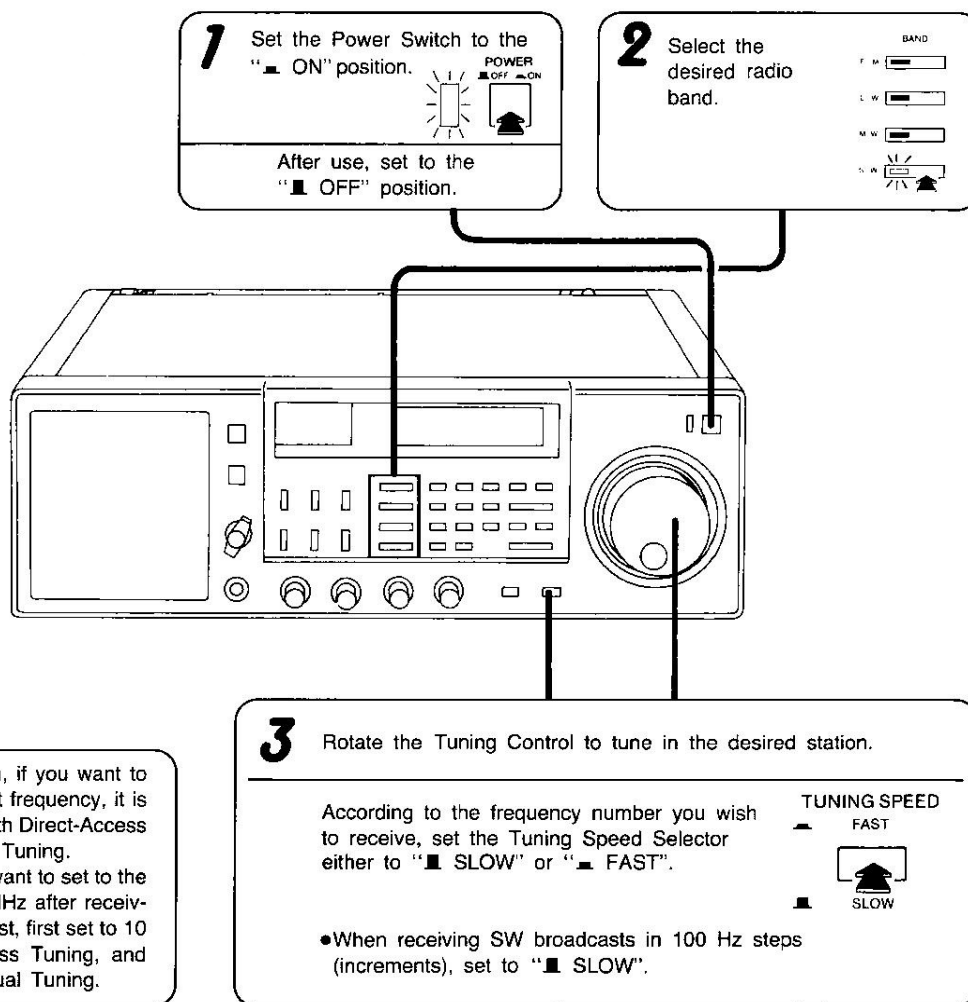

■ SSB and CW Reception

- 1) Receive SW broadcast by the Manual Tuning.
- 2) Set the AM Mode Selector to "CW/LSB" or "CW/USB" position.
- 3) Set the Tuning Speed Selector to "SLOW" position.
- 4) Adjust to receive signals by rotating the Tuning Control. SSB... Rotate this control until the received signal becomes clear. CW... Adjust for the desired tone. Usually for amateur communication, LSB is used under 10 MHz and USB used over 10 MHz.

Note:

In receiving two-way communication signals, a possible difference between the two frequencies may demand further adjustment of the Tuning Control.

C Memory Tuning

When broadcast stations selected with either the Direct-Access Tuning or Manual Tuning modes are entered into the memory channels (channels 1~9), you can recall those selected channels easily, merely by pressing the corresponding Memory Channel Key.

D Memory Scan Tuning

The memory scan function plays in order each of the stations memorized in the memory channels. It is a convenient feature when you wish to scan the program contents presently being broadcasted on each of the memory channels, or when you wish to search for a particular broadcast.

• How to memorize the channel

- 1** Use the Direct-Access Tuning or Manual Tuning mode to select a channel you wish to memorize.

88.10 MHz

(When 88.10 MHz is received)

- 2** Press the Memory Key (The memory display "ME" will appear).

ME 88.10 MHz

If you wish to cancel the station, press the Memory Key again.

Memory Tuning

- Press the Memory Channel Key to receive your desired station.

CH 5 88.10 MHz

4

With these steps, the memorization of one channel is completed. Repeat steps 1~3 to memorize stations in each of the remaining Memory Channel Keys.

- When a new frequency is memorized in a given channel, the frequency previously memorized in the channel will be cancelled.

- 3** Press the Memory Channel Key into which you wish to memorize the selected station. (The memory display will disappear, and the selected channel number display will appear.)

CH 5 88.10 MHz

(When channel 5 is memorized.)

Memory Scan Tuning

- 1** Press the Decimal Point/Memory Scan Key.

•/M-SCAN

The channels will change in the order CH1→CH2...CH8→CH9→CH1→CH2... to each channel broadcasting for about 3 seconds.

- 2** When your desired memory channel is displayed, pressing the Stop Key or the Memory Channel Key will allow you to receive that broadcast.

STOP or 7

CH 7 1010. KHZ

E SW Zone Auto Tuning

During SW reception, if you do not know the precise frequency of your desired broadcast, you can use this tuning method in combination with the manual, scan or seek tuning modes to search for your desired station within a ± 150 kHz range of a selected central frequency.

1 Manual Mode

1

Use the Direct-Access Tuning mode or Manual Tuning mode to tune in a frequency in the vicinity of your desired station.

9.670 MHz

(Tuned to 9.670 MHz)

2

Press the "MANUAL" button of the SW Zone Auto Tuning Selector.

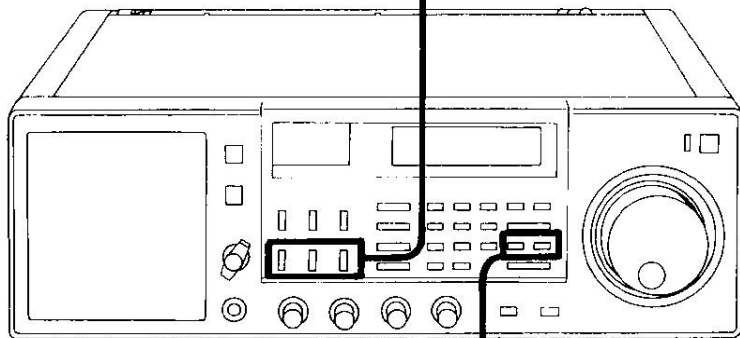
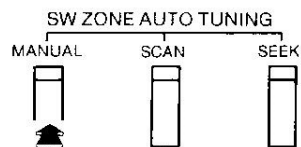

3

Press one of the Tuning Keys (UP or DOWN) one by one to search for your desired station. When the Tuning Key is pressed, the Digital Frequency Display will change in 5 kHz steps (increments). While the Tuning Key is being depressed, the Digital Frequency Display will change in faster mode.

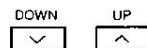

2 Scan Mode

1

Use the Direct-Access Tuning mode or Manual Tuning mode to tune in a frequency in the vicinity of your desired station.

9.670 MHz

(Tuned to 9.670 MHz).

2

Press the "SCAN" button of the SW Zone Auto Tuning Selector.

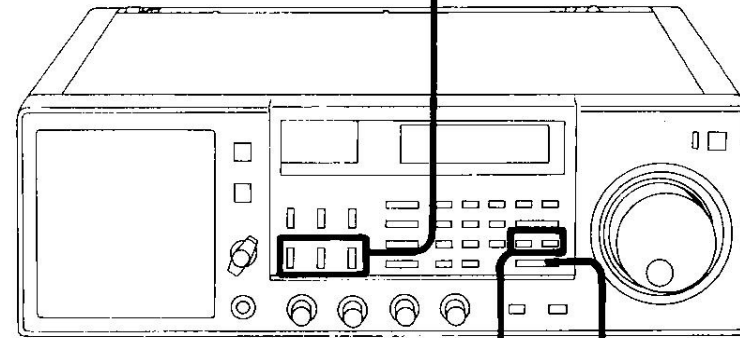
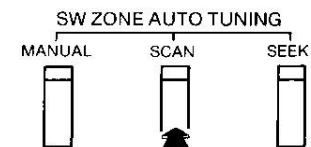

3

Press one of the Tuning Keys (UP or DOWN).

- The Digital Frequency Display will automatically change in 5 kHz steps.

- When a broadcast is received, the scan will stop for about 3 seconds, and then begin scanning again automatically.

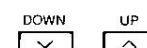

4

When you have found your desired station, or if you wish to cancel the scanning operation, press the Stop Key.



3 Seek Mode

1 Use the Direct-Access Tuning mode or Manual Tuning mode to tune in a frequency in the vicinity of your desired station.

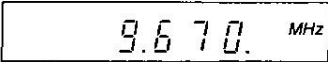

(Tuned to 9.670 MHz).

2 Press the "SEEK" button of the SW Zone Auto Tuning Selector.

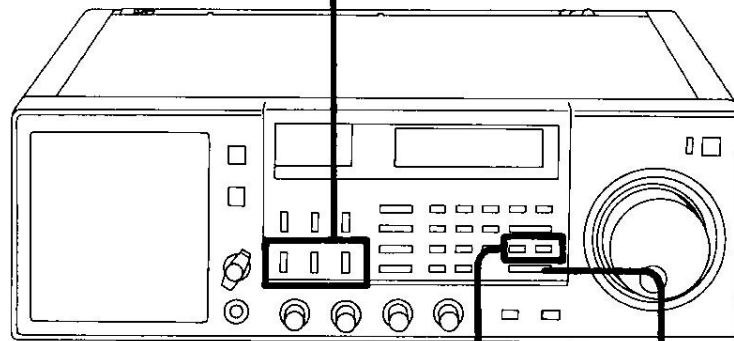
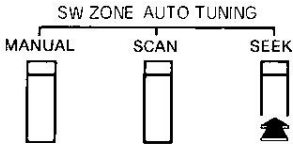

3 Press one of the Tuning Keys (UP or DOWN).



- The Digital Frequency Display will change automatically in 5 kHz steps.
- When a broadcast is received, the Up or Down tuning operation will stop.

4 Press the Stop Key if you wish to cancel the seek operation.



Notes:

- During SW Zone Auto Tuning, the Tuning Speed Selector does not operate. The digital frequency display will change in 5 kHz steps, regardless of the position of the switch ("■ FAST" or "■ SLOW").
- During the Seek operation, when a strong signal is received, the operation will automatically stop, but possibly not at the signal's central frequency. For example, if a strong 6.055 MHz signal is received, the seek operation will stop at 6.050 MHz or 6.060 MHz. In this case, use the Tuning Control for fine tuning.
- During Seek or Scan operation, when the noise is too loud, the operation will automatically stop at every 5 kHz step. In this case, turn the AM RF Gain Control a little toward the "LOCAL" direction.

CONNECTIONS

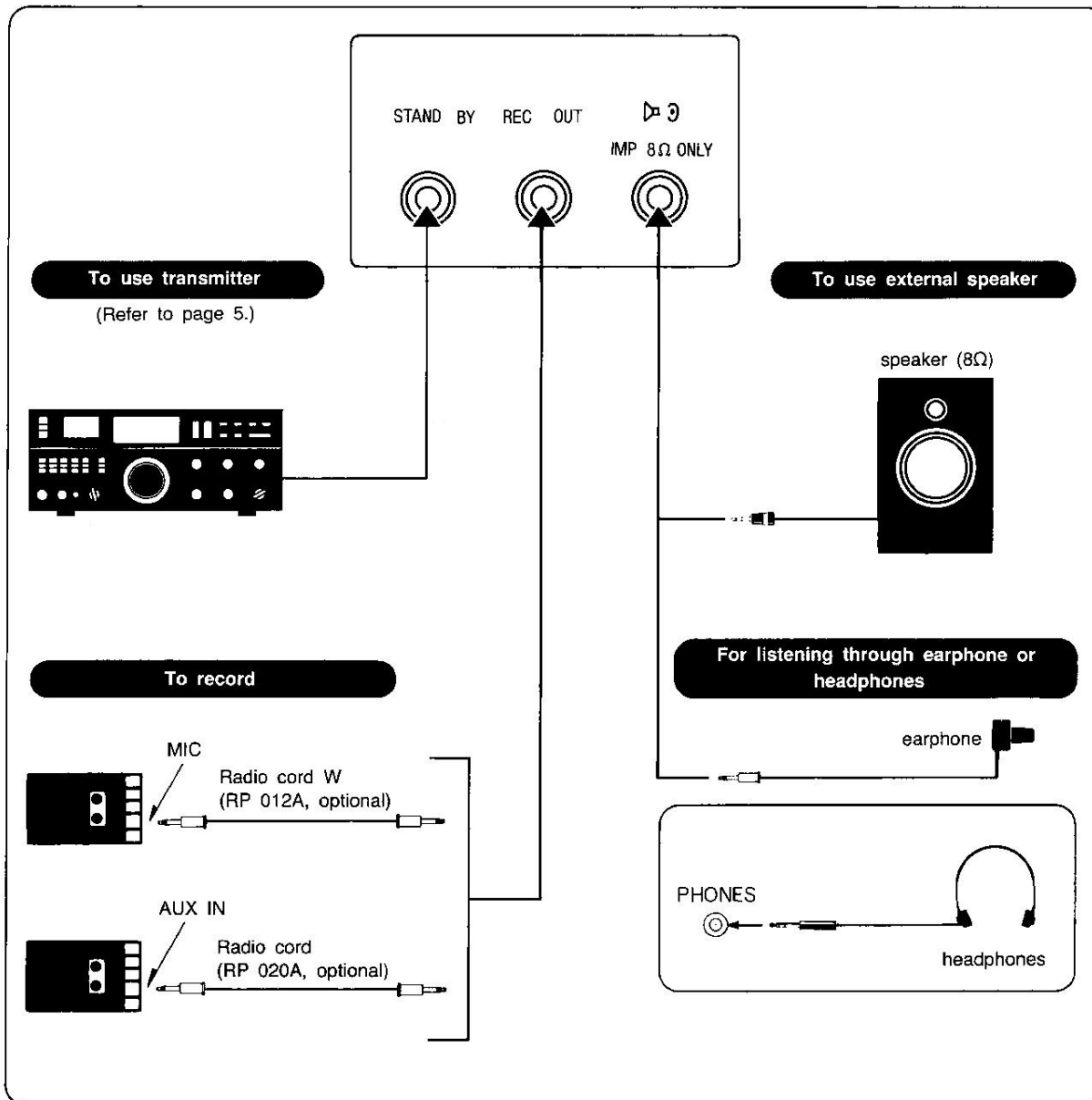

SUGGESTIONS FOR SAFETY

Before using this unit, be sure to read applicable items of the operating instructions and these safety suggestions carefully; and afterwards keep them handy for future reference. Take special care to follow the warnings indicated on the unit itself as well as in the operating instructions.

- 1. Avoid places where there is water or humidity.**
Do not use this unit near a bathtub, washbasin, swimming pool, or the like. Damp basements should also be avoided.
- 2. Don't allow water or any foreign object to get inside this unit.**
Don't place small metal objects or anything containing liquid on or near the unit.
- 3. Avoid placement of the unit where it will be exposed to the direct rays of the sun, or where ventilation is inadequate.**
Don't place this unit in a bookcase or between cabinets, or where curtains or furniture may obstruct the ventilation holes.
- 4. Place this unit away from heat-emitting appliances.**
Never place this unit near a radiator, heat register, stove, or any other heat-emitting equipment. (Including Amplifiers).
- 5. Placement**
Place the unit on a stable, vibration-free, level shelf or stand.
- 6. Check the voltage rating of this unit before connecting the unit to a power supply.**
Be sure to connect the unit only to the type of power supply indicated in the operating instructions, or as indicated on the unit itself.
- 7. Concerning the power outlet(s) of this unit.**
If this has a built-in electric power receptacle, be sure to connect only equipment with a power rating not exceeding that indicated by the receptacle of this unit. (Only connect audio equipment to this outlet.)
- 8. Care of the power cord and plug.**
Take care that the cord is not bent sharply (especially near its connection to the unit or near the plug), that nothing is placed on it, and that it is not pinched or crushed. Never take hold of the plug or cord if your hand is wet, and always be sure to grasp the plug body when connecting or disconnecting it.

9. Outdoor Antenna grounding.

If an outside antenna is connected to the receiver, be sure the antenna system is grounded so as to provide some protection against voltage surges and built up static charges. Section 810 of the National Electrical Code, ANSI/NFPA. No. 70—1981, provides information with respect to proper grounding of the mast and supporting structure, grounding of the lead-in wire to an antenna discharge unit, size of grounding conductors, location of antenna-discharge unit, connection to grounding electrodes, and requirements for the grounding electrode. See the figure to the below.

EXAMPLE OF ANTENNA GROUNDING AS PER NATIONAL ELECTRICAL CODE INSTRUCTIONS

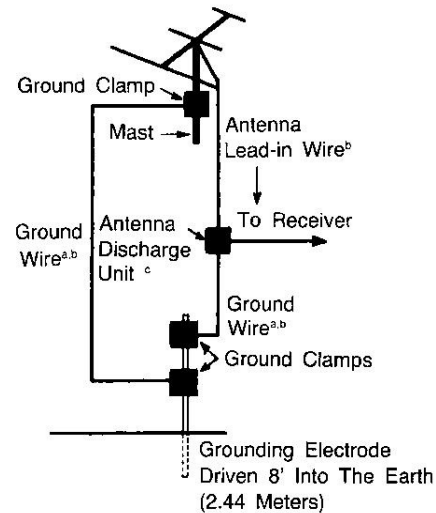

- a) Use No. 10 AWG (5.3 mm²) copper or No. 8 AWG (8.4 mm²) aluminum or No. 17 AWG (1.0 mm²) copper-clad steel or bronze wire, or larger as, ground wire.
- b) Secure antenna lead-in and ground wires to house with stand-off insulators, spaced from 4 feet (1.22 m) to 6 feet (1.83 m) apart.
- c) Mount antenna discharge unit as close as possible to where lead-in enters house.

10. Power lines

When installing an outdoor antenna, install it as far as possible from power lines.

11. If the unit will not be used for a long period of time:

Be sure to disconnect the power cord.

12. Maintenance

Refer to the operating instructions for details.

13. Never attempt repairs yourself:

- (a) If the power cord or plug is damaged.
- (b) If a foreign object or liquid falls into the unit.
- (c) If the unit is exposed to rain.
- (d) If the unit does not function normally, or if operation shows an unusual change.
- (e) If the unit has been dropped and the cabinet or chassis are damaged...etc.

Unplug the power cord and consult with a qualified technician (or the dealer from whom the unit was purchased or the nearest service center).

14. Repairs

Except for adjustments explained in the operating instructions, do not attempt any repairs yourself. Be sure to request service from a qualified technician (or your dealer or nearest service center).

SPECIFICATIONS

FM		Selectivity:	WIDE; ± 3.5 kHz (-6 dB) ± 7 kHz (-60 dB)	General	
Frequency Range:	87.5-108 MHz		NARROW; ± 1.5 kHz (-6 dB) ± 4 kHz (-60 dB)	Speaker:	3 1/2" PM dynamic speaker
IF:	10.7 MHz			Power Source:	AC; 110-115/115-127/200-220/ 230-250 V, 50/60 Hz
Sensitivity:	2.5 μ V/75 Ω (-3 dB, Limit Sens) 2.5 μ V/75 Ω (S/N 26 dB)	Image Interference Ratio:	40 dB (at 1,000 kHz)		Power consumption; 16 W
Image Interference Ratio:	30 dB (at 98 MHz)	SW		Battery:	12 V (eight "D", UM-1 size batteries...for radio) 4.5 V (three "AA", UM-3 size batteries...for memory back-up)
Two Signal Selectivity:	70 dB (± 400 kHz)	Type:	Double Superheterodyne with PLL Synthesizer		Car battery; use only car adaptor RP-952
LW		Frequency Range:	1.6110-29.9999 MHz	Jacks:	DC IN AC IN STAND BY 1/8" \varnothing REC OUT 1/8" \varnothing EP/EXT SP 1/8" \varnothing PHONES 1/4" \varnothing
Frequency Range:	150-420 kHz	IF:	1st; 39.9-40.0 MHz 2nd; 450 kHz	Ext. Ant:	LW/MW/SW ANT (M-Type Connector) (50-75 Ω) FM ANT (75 Ω) SW ANT (HIGH IMP) LW/MW/SW ANT (LOW IMP)
IF:	450 kHz	Sensitivity (400 Hz, 30% Modulation 50 mW):	S/N 6 dB; 1.2 μ V (50 Ω) (at 6 MHz) S/N 26 dB; 10 μ V (50 Ω) (at 6 MHz)	Dimensions:	14 1/16" (W) \times 4 3/16" (H) \times 11 1/2" (D)
Sensitivity:	S/N 6 dB; 70 μ V/m S/N 26 dB; 600 μ V/m (at 280 kHz)	Selectivity:	WIDE; ± 3.5 kHz (-6 dB) ± 7 kHz (-60 dB) NARROW; ± 1.5 kHz (-6 dB) ± 4 kHz (-60 dB)	Weight:	10 lbs 2.3 oz (without batteries)
Selectivity:	WIDE; ± 3.5 kHz (-6 dB) ± 7 kHz (-60 dB) NARROW; ± 1.5 kHz (-6 dB) ± 4 kHz (-60 dB)	Image Interference Ratio:	50 dB (at 6 MHz)		
Image Interference Ratio:	35 dB (at 280 kHz)	Frequency Stability:	Within 50 Hz during any 60 minutes after warm-up time		
MW					
Frequency Range:	520-1610 kHz				
IF:	450 kHz				
Sensitivity:	S/N 6 dB; 35 μ V/m S/N 26 dB; 400 μ V (at 1,000 kHz)				

Specifications are subject to change without notice.

PRODUCT SERVICE

Should your Panasonic product ever require service, refer to enclosed Directory for an Authorized Panasonic Servicecenter or consult your authorized Panasonic dealer for detailed instructions.

SERIAL NUMBER: Located on the label affixed to the inside of the radio battery compartment.

Panasonic Company
Division of Matsushita Electric Corporation of America
 One Panasonic Way, Secaucus, New Jersey 07094
Panasonic Hawaii Inc.
 91-238 Kauhi St. Ewa Beach P.O. Box 774
 Honolulu, Hawaii 96808-0774